



Epson MovieMate™ 50

Quick Guide

Setting Up
Playing Movies
Solving Problems



Contents

Welcome	3
Registration and Warranty	4
Unpacking and Setting Up	5
Unpacking	5
Choosing a Location	6
Setting Up Epson MovieMate	8
Watching Movies	9
Starting a DVD Movie	9
Adjusting the Picture	10
Fine-Tuning the Image Size	12
Adjusting the Color	12
Pausing a Movie and Turning On the Light	13
Turning Off Epson MovieMate	13
Solving Problems	14
Where To Get Help	16
Notices	17
Important Safety Instructions	17
Epson America, Inc. Limited Warranty	19

Welcome

Your Epson MovieMate™ 50 is a portable, lightweight home cinema system that delivers high-quality, big-screen entertainment anywhere you want. In just a few minutes, you can set up MovieMate and watch a DVD, play a video game, or view your favorite photos.

Follow the instructions in this guide to:

- Choose a location
- Set up MovieMate
- Start playing a movie
- Adjust the image and sound
- Solve common problems

See the *User's Guide* on the Epson MovieMate CD for additional instructions, including connecting a cable or satellite TV receiver, game console, MP3 player, sound system, computer, and more.

Please follow these guidelines as you read the instructions:

Warning:

Warnings must be followed carefully to avoid bodily injury.

Caution:

Cautions must be observed to avoid damage to your equipment.

Note:

Notes contain important information about MovieMate.

Registration and Warranty

Your Epson MovieMate comes with a basic two-year carry-in warranty. For details, see page 19.

In addition, Epson® offers free Extra CareSM Home Service during your warranty period. In the unlikely event of an equipment failure, you won't have to wait for your unit to be repaired. Instead, Epson will ship you a replacement unit anywhere in the United States or Canada, usually via overnight delivery. See your Extra Care Home Service brochure for details.

We encourage you to register your Epson MovieMate. You can register using the CD that came in the box. Or you can register online at <http://www.epson.com/webreg>. Registering also lets you receive special updates on new accessories, products, and services.

Unpacking and Setting Up

Follow these instructions to unpack and set up your Epson MovieMate.

Unpacking

Make sure you have all the parts shown here:

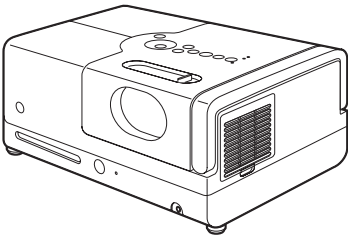

MovieMate

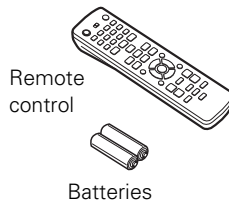

Remote control

Batteries

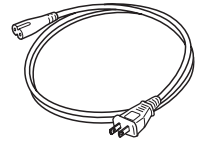

Power cord



CD with *User's Guide*

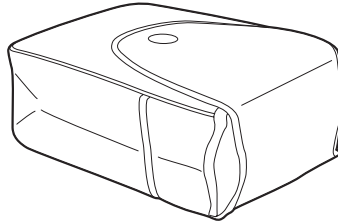

Padded bag

Choosing a Location

You can use your Epson MovieMate just about anywhere—in the living room, bedroom, or even outside. You can use it with an optional floor-, wall-, or ceiling-mounted screen, or simply project on a flat white wall.

The following pictures show three different setups:

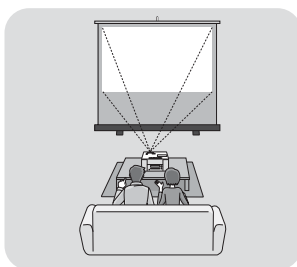

Front

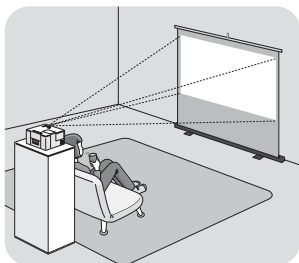

Back

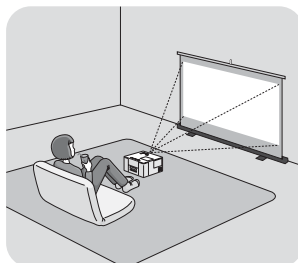

Floor

- To project onto a wall, choose a flat white wall with a smooth surface. When you find a suitable wall for projection, you may want to consider coating the area with projection paint to enhance the image quality. For details, see the *User's Guide* on the Epson MovieMate CD.

- MovieMate should be directly in front of the screen or wall, facing straight ahead (at a 90-degree angle to the surface).
- If the image is too low, you can raise it by extending the feet to tilt MovieMate up. This causes the image to lose its rectangular shape. You can adjust the shape using the keystone buttons on MovieMate or on the remote control. See page 10 for instructions.
- The farther you place MovieMate from the screen or wall, the larger the image will be.

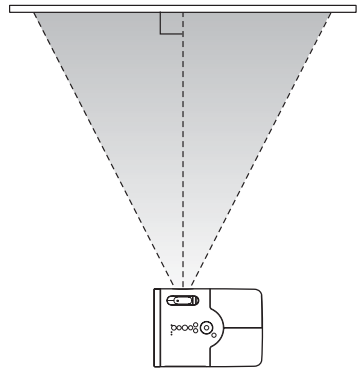

If you want an 80-inch diagonal widescreen image, place MovieMate about 7.8 feet away from the wall or screen. The following diagram shows the approximate image size (measured diagonally) at various distances.

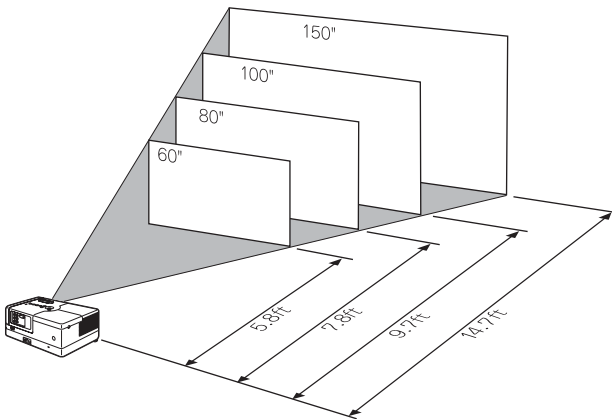



Caution:

MovieMate should not be exposed to water, smoke, moisture, dust, direct heat or sunlight, or left outside for long periods of time. These environmental factors may cause damage to internal electronics over time. See the warranty on page 19 for additional details.

Setting Up Epson MovieMate

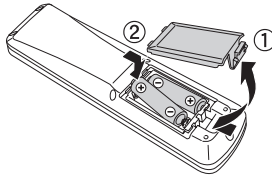
1. If you have a screen, set it up following the instructions included with the screen. Make sure you read all the instructions to avoid damaging the screen.
2. Put the batteries in the remote control.



3. Expose the remote control to bright light for several minutes before using it in the dark. The buttons will glow in the dark briefly.
4. Open the lens cover, then connect the power cord and plug in MovieMate. The  light turns orange.

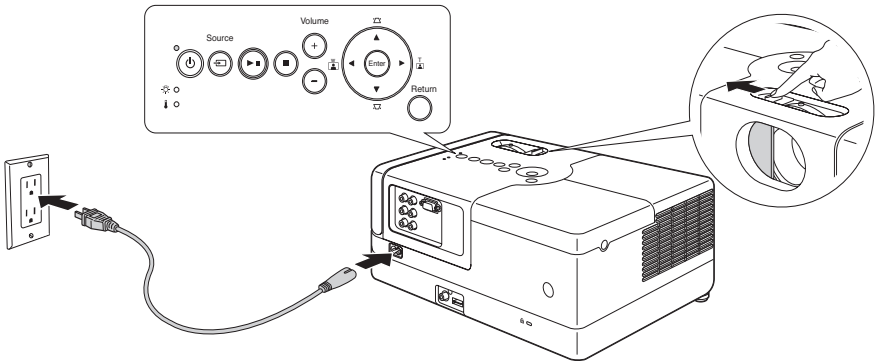

Watching Movies

After you get your Epson MovieMate set up and plugged in, it's easy to start playing your movie. Follow the instructions in this section to adjust the picture and sound for the best home cinema experience.

Starting a DVD Movie

1. Insert your DVD into the slot.

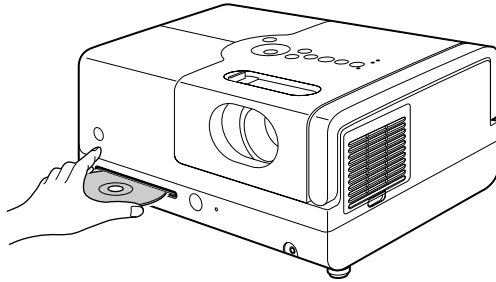

Warning:

When the picture appears, do not look into the lens, and do not allow children or pets to look into the lens. The bright light may affect your vision.

After about 30 seconds, MovieMate warms up and the picture comes on.

2. To adjust the volume, use the **+** or **- Volume** buttons on the control panel or on the remote control.

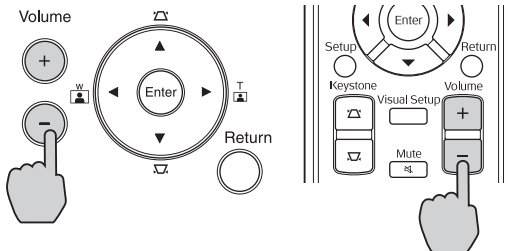

Adjusting the Picture

Once you see your picture, you may need to make some adjustments.

- If the image is too low, you can extend the feet (by rotating them) and tilt MovieMate up.

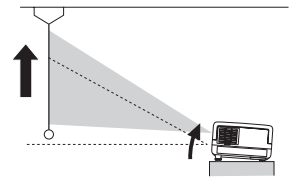
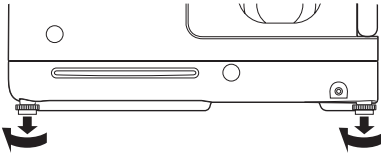

If you tilt MovieMate, the image will lose its rectangular shape. Use the **Keystone** buttons on the remote control or the control panel to adjust the image shape.

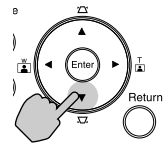
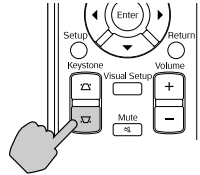
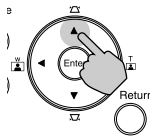
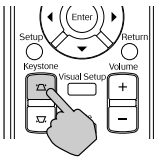
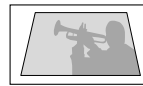

- Press the **W** and **T** arrows on the control panel to adjust the image size. For more ways to adjust the size, see page 12.

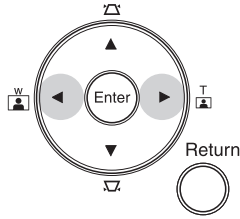
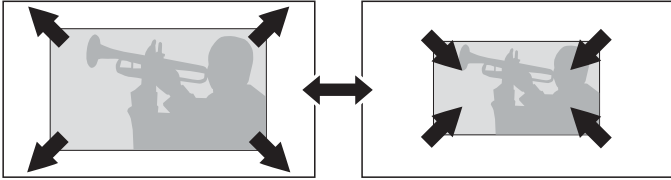

- Rotate the focus ring to sharpen the picture.

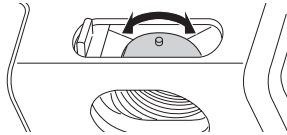

Fine-Tuning the Image Size

Most of the time MovieMate adjusts the picture automatically for wide-screen or normal video.

However, you can adjust the width to height proportion (aspect ratio) manually if necessary. You can also zoom in or out.

- For non-widescreen DVDs, press the ^{Aspect}  button on the remote control and select Full, Zoom, or Normal.

Full projects a widescreen image (16:9 aspect ratio) that is slightly stretched.

Zoom projects a widescreen image (16:9 aspect ratio), with the top and bottom slightly cut off.

Normal projects the image in its original proportions (4:3 aspect ratio).

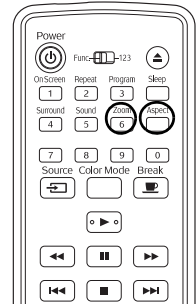



- To zoom in, press the ^{Zoom}  button on the remote control. Continue pressing to zoom in up to 5 times. The edges will be cut off, but you can use the arrow buttons on the remote to pan around the picture.

Continue pressing the ^{Zoom}  button to zoom out to 1/4 size, then back to the original size.

Adjusting the Color

You can change the color mode to optimize picture quality based on the lighting conditions in the room.

For example, the **Dynamic** color mode provides the brightest picture, and works best when you use MovieMate outdoors or in a well-lit room. However, when you use MovieMate in a darkened room, one of the other color modes will improve the colors in your image.

1. Press ^{Color Mode} . The currently selected color mode is displayed on the screen.
2. Press ^{Color Mode}  again to change the color mode, then wait a moment until you see the picture quality change.

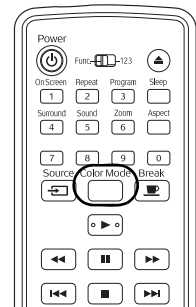







You can select from the following color modes, depending on the video source:

- **Dynamic:** Use in rooms with bright light.
- **Living Room:** Use in rooms with the blinds or drapes closed.
- **Theatre:** Use in completely darkened rooms.
- **Game:** Use for playing high-speed games in a bright room (available only with external equipment).

Pausing a Movie and Turning On the Light

When you pause a movie, you can have Epson MovieMate light up the screen or wall temporarily. This works great when you need to get more popcorn!



- To pause a movie and light up the screen, press the  button on the remote control.
- To resume, press  again. Pressing any of the following buttons also cancels break mode: , , , or .

Note:

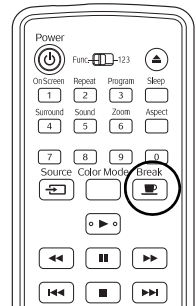
After 5 minutes in break mode, the lamp turns off and the screen darkens. After 30 minutes, the power shuts off, and you need to press the  button to turn it on again.





Turning Off Epson MovieMate

1. To stop playing a DVD, press  on the remote control or control panel.
2. Press the  button to eject the DVD, then remove it from the slot.
3. Press . The lamp turns off. When it cools down, MovieMate beeps twice.
4. Close the lens cover and unplug the power cable.

Solving Problems

If you don't find the solution to your problem here, see the *User's Guide* on the Epson MovieMate CD for more troubleshooting tips.



No picture appears on the screen.

- Make sure MovieMate is turned on (the  light is green and not flashing). If the  light is flashing green, wait for MovieMate to warm up.
- Make sure the lens cover is open.
- The Screensaver feature turns off the picture if a still image is projected for more than 15 minutes.

The picture is blurry or out of focus.

- Adjust the focus using the focus ring. See page 11 for instructions.
- There may be dirt on the lens. Clean the lens with lens-cleaning paper or a soft cloth.
- Make sure the lens is not fogged by condensation. If you've just moved MovieMate from a cold environment, wait approximately an hour before using it. If condensation forms, unplug MovieMate and wait an hour or two before use.
- Make sure MovieMate is placed the correct distance from the screen: no closer than 2.9 feet and no farther than 48.6 feet.
- If you're using the **Keystone** adjustment, be aware that it lessens image quality. You may want to decrease the projection angle to reduce the amount of keystone correction needed. Try adjusting MovieMate's position relative to the screen.

The picture is wider at the top or bottom.

You've tilted MovieMate to raise or lower the image, causing it to become "keystoned." Use the  or  buttons on the control panel or remote control to correct the problem. If you are unable to correct the distortion, you may need to reduce the degree of tilt.

The picture is taller on the left or right side.

MovieMate is set at an angle to the screen. Face it squarely toward the screen.

The remote control doesn't work.

- Make sure the toggle switch is in the correct position: set to -123 to use the numeric buttons, or to Func.- to use the other functions of these buttons.
- Make sure you're within 19 feet of MovieMate, and within range of its front or back sensor (approximately 30° left or right, and 15° above or below).
- You may need to replace the remote control's batteries. Make sure they're inserted with the positive (+) and negative (-) ends positioned as shown in the battery compartment.
- Some DVDs don't support all of the remote control's functions.
- If you're using a "universal" remote control, it might not work with MovieMate. Epson does not support any third-party remote controls.

Where To Get Help

Epson provides these technical support services:

Internet Support

Visit Epson's U.S. support website at epson.com/support or Canadian support website at epson.ca/support. Select your product for solutions to common problems. You can download utilities and documentation, get FAQs and troubleshooting advice, or e-mail Epson with your questions.

Speak to a Support Representative

To use the Epson PrivateLine® Support service, call (800) 637-7661 and enter the PIN on the included Epson PrivateLine Support card. This is the fastest way of speaking to a live representative, and it's free. This service is available 6 AM to 6 PM, Pacific Time, Monday through Friday, for the duration of your warranty period.

You may also speak with a projector support specialist by dialing one of these numbers:

- U.S.: (562) 276-4394, 6 AM to 6 PM, Pacific Time, Monday through Friday
- Canada: (905) 709-3839, 6 AM to 6 PM, Pacific Time, Monday through Friday

Toll or long distance charges may apply.

Before you call Epson for support, please have the following information ready:

- Product name (Epson MovieMate 50)
- Product serial number (located on the bottom of MovieMate)
- Proof of purchase (such as a store receipt) and date of purchase
- Computer or video configuration
- Description of the problem

Purchase Supplies and Accessories

You can purchase screens, carrying cases, or other accessories from an Epson authorized reseller. To find the nearest one, call 800-GO-EPSON (800-463-7766). Or you can purchase online at www.epsonstore.com (U.S. sales) or www.epson.ca (Canadian sales).

Notices

Important Safety Instructions

Follow these safety instructions when setting up and using your Epson MovieMate:

- Except as specifically explained in the *User's Guide* on the Epson MovieMate CD, do not attempt to service this product yourself. Refer all servicing to qualified service personnel.
- Never open any cover on the projector, except the lamp and filter covers. Dangerous electrical voltages inside the projector can severely injure you.
- The projector and its accessories come packaged in plastic bags. Keep plastic bags away from small children to avoid any risk of suffocation.
- Never look into the projector lens when the lamp is turned on; the bright light can damage your eyes. Never let children look into the lens when it is on.
- Don't place the projector on an unstable cart, stand, or table. Also, don't stand on the projector or place heavy objects on it.
- Never push objects through the cabinet slots or spill liquid into the projector.
- Do not use the projector near water, or sources of heat or vibration. Do not expose it to rain or moisture.
- Do not move the unit during playback.
- Do not touch the projection lens with bare hands.
- Use a damp cloth for cleaning. Do not use liquid or aerosol cleaners. Unplug the projector from the wall outlet before cleaning.
- Never try to remove the lamp immediately after use. Doing so will result in serious burns. Before removing the lamp, turn off the projector and wait approximately one hour for the lamp to cool completely.
- The lamp is fragile and can easily break. If the lamp breaks, handle the projector with extreme care to avoid injury from broken glass, and contact Epson to replace the lamp.
- Do not use the lamp after the lamp replacement period has elapsed, because the possibility of lamp breakage increases. When the lamp replacement message appears, replace the lamp with a new one as soon as possible.
-  The lamp in this product contains mercury. Please consult your state and local regulations regarding disposal or recycling. Do not put in the trash.

- The lamp in this projector is under high internal pressure and may make a loud noise if it breaks. If it breaks, ventilate the room to prevent mercury gas inside the lamp from being inhaled or coming into contact with the eyes or mouth.
- Do not bring your face close to the projector while it is in use, to prevent inhaling or contact with the gases inside the lamp if it breaks.
- If the lamp breaks and gas from the lamp or fragments of broken glass are inhaled or get into the eyes or mouth, or if any other ill effects are noticed, immediately seek medical advice.
- Use the type of power source indicated on the projector. If you're not sure of the power available, consult the power company.
- If you use the projector in a country other than where you purchased it, use the correct power cord for that country.
- Place the projector near a wall outlet where the plug can be easily unplugged.
- Don't place the projector where the cord can be walked on. This may result in fraying or damage to the plug.
- Don't insert the plug into an outlet with dust present, and insert the plug firmly into the outlet. Failure to do so could result in sparks or fire.
- Don't handle the plug with wet hands.
- Don't overload wall outlets, extension cords, or integral convenience receptacles. This can cause fire or electric shock.
- Unplug the projector from the wall outlet and refer servicing to qualified service personnel under the following conditions: when the power cord or plug is damaged or frayed; if liquid has been spilled into the projector, or if it has been exposed to rain, water, or excessive humidity; if it doesn't operate normally when you follow the operating instructions, or if it exhibits a distinct change in performance, indicating a need for service; if it has been dropped or the housing has been damaged.
- If there is an electrical storm, do not touch the power plug, otherwise you may receive an electric shock.
- Keep the projector unplugged during electrical storms and when the projector is not in use for extended periods.
- Keep the batteries for the remote control out of the reach of children. Batteries are choking hazards and can be very dangerous if swallowed. If they are swallowed, seek medical attention immediately.
- Replace the batteries as soon as they run out.
- Do not expose batteries to heat or flame.
- Dispose of used batteries according to local regulations.
- Remove the batteries if you won't be using the projector for an extended period.

- Don't block the slots and openings in the projector case. They provide ventilation and prevent the projector from overheating. Don't operate the projector on a sofa, rug, or other soft surface, or in a closed-in cabinet unless proper ventilation is provided.
- Don't leave the projector or remote control on top of heat-producing equipment or in a heated place, such as a car.
- Don't use the projector outside of the required temperature range (41 to 95 °F). Doing so may cause an unstable display and could lead to projector damage.
- Don't store the projector outside of the required temperature range (14 to 140 °F) or in direct sunlight for long periods of time. Doing so may cause damage to the case.
- Make sure there is at least 8 inches of space between the exhaust ventilation slots and the wall or other object.
- Make sure there is at least 4 inches of space between the intake ventilation slots and the wall or other object.
- Avoid projecting a high-contrast still image for more than 15 minutes to prevent burn-in. If this happens, project a bright screen until the burn-in disappears (from 30 to 60 minutes. If you can't eliminate the burn-in, contact Epson as described on page 16).
- Do not turn the volume too high, especially when using headphones. Listening to high volume sounds over an extended period can damage your hearing. Sudden high volume can also damage the speakers.

WARNING: The cord included with this product contains chemicals, including lead, known to the State of California to cause birth defects or other reproductive harm. *Wash hands after handling.* (provided in accordance with Proposition 65 in Cal. Health & Safety Code § 25249.5 et seq)

Epson America, Inc. Limited Warranty

Basic Two-Year Warranty and 90-Day Lamp Warranty

What Is Covered: Epson America, Inc. (“Epson”) warrants to the original retail purchaser of the Epson product enclosed with this limited warranty statement that the product, if purchased new and operated in the United States or Canada, will be free from defects in workmanship and materials for a period of two (2) years from the date of original purchase (except that the warranty period is 90 days for projector lamps). For warranty service, you must provide proof of the date of original purchase.

What Epson Will Do To Correct Problems: If your product requires service, Epson will ask you to bring the product securely packaged in its original container or equivalent, along with proof of the date of original purchase, to your Epson Dealer or Epson Customer Care Center as instructed by Epson. Epson will, at its option, repair or replace the defective unit, without charge for parts or labor. When warranty service involves the exchange of the product or of a part, the item replaced becomes Epson property. The exchanged product or part may be new or previously refurbished to the Epson standard of quality, and at Epson's option, the replacement may be another model of like kind and quality. Epson's liability for replacement of the covered product will not exceed the original retail selling price of the covered product. Exchange or replacement products or parts assume the remaining warranty period of the product covered by this limited warranty. However, each replacement lamp carries the limited 90-day warranty stated above.

What This Warranty Does Not Cover: This warranty covers only normal use of the product. 24-hour-per-day or other high duty commercial use causes strain and is not considered normal use. This warranty does not cover consumables (e.g., filters), other than lamps as provided herein. This warranty is not transferable. Epson is not responsible for warranty service should the product fail to be properly maintained or fail to function properly as a result of misuse, abuse, improper installation, neglect, improper shipping, damage caused by disasters such as fire, flood, and lightning, improper electrical current, software problems, interaction with non-Epson products, use in a smoke- or dust-filled environment, or service other than by an Epson Authorized Servicer. Postage, insurance, or shipping costs incurred in presenting your Epson product for carry-in warranty service are your responsibility. If a claimed defect cannot be identified or reproduced in service, you will be held responsible for costs incurred.

THE WARRANTY AND REMEDY PROVIDED ABOVE ARE EXCLUSIVE AND IN LIEU OF ALL OTHER EXPRESS OR IMPLIED WARRANTIES INCLUDING, BUT NOT LIMITED TO, THE IMPLIED WARRANTIES OF MERCHANTABILITY OR FITNESS FOR A PARTICULAR PURPOSE. SOME LAWS DO NOT ALLOW THE EXCLUSION OF IMPLIED WARRANTIES. IF THESE LAWS APPLY, THEN ALL EXPRESS AND IMPLIED WARRANTIES ARE LIMITED TO THE WARRANTY PERIOD IDENTIFIED ABOVE. UNLESS STATED HEREIN, ANY STATEMENTS OR REPRESENTATIONS MADE BY ANY OTHER PERSON OR FIRM ARE VOID. IN THE EVENT THE REMEDIES ABOVE FAIL, EPSON'S ENTIRE LIABILITY SHALL BE LIMITED TO A REFUND OF THE PRICE PAID FOR THE EPSON PRODUCT COVERED BY THIS LIMITED WARRANTY. EXCEPT AS PROVIDED IN THIS WRITTEN WARRANTY, NEITHER EPSON AMERICA, INC. NOR ITS AFFILIATES SHALL BE LIABLE FOR ANY LOSS, INCONVENIENCE, OR DAMAGE, INCLUDING DIRECT, SPECIAL, INCIDENTAL, OR CONSEQUENTIAL DAMAGES, RESULTING FROM THE USE OR INABILITY TO USE THE EPSON PRODUCT, WHETHER RESULTING FROM BREACH OF WARRANTY OR ANY OTHER LEGAL THEORY.

In Canada, warranties include both warranties and conditions.

Some jurisdictions do not allow limitations on how long an implied warranty lasts and some jurisdictions do not allow the exclusion or limitation of incidental or consequential damages, so the above limitations and exclusions may not apply to you. This warranty gives you specific legal rights, and you may also have other rights, which vary from jurisdiction to jurisdiction.

To find the Epson Authorized Reseller nearest you, visit our website at: www.epson.com.

To find the Epson Customer Care Center nearest you, visit epson.com/support.

You can also call the Epson ConnectionSM at (800) 637-7661 + PIN or (562) 276-4394 in the U.S. and (905) 709-3839 in Canada or write to: Epson America, Inc., P.O. Box 93012, Long Beach, CA 90809-3012.

Declaration of Conformity

According to 47CFR, Part 2 and 15 for: Class B Personal Computers and Peripherals; and/or CPU Boards and Power Supplies used with Class B Personal Computers:

We: Epson America, Inc.
Located at: MS 3-13
3840 Kilroy Airport Way
Long Beach, CA 90806
Telephone: (562) 290-5254

Declare under sole responsibility that the product identified herein, complies with 47CFR Part 2 and 15 of the FCC rules as a Class B digital device. Each product marketed is identical to the representative unit tested and found to be compliant with the standards. Records maintained continue to reflect the equipment being produced can be expected to be within the variation accepted, due to quantity production and testing on a statistical basis as required by 47CFR §2.909. Operation is subject to the following two conditions: (1) this device may not cause harmful interference, and (2) this device must accept any interference received, including interference that may cause undesired operation.

Trade Name: Epson
Type of Product: Projector
Model: EMP-DM1

FCC Compliance Statement

For United States Users

This equipment has been tested and found to comply with the limits for a Class B digital device, pursuant to Part 15 of the FCC Rules. These limits are designed to provide reasonable protection against harmful interference in a residential installation. This equipment generates, uses, and can radiate radio frequency energy and, if not installed and used in accordance with the instructions, may cause harmful interference to radio or television reception. However, there is no guarantee that interference will not occur in a particular installation. If this equipment does cause interference to radio and television reception, which can be determined by turning the equipment off and on, the user is encouraged to try to correct the interference by one or more of the following measures:

- Reorient or relocate the receiving antenna.
- Increase the separation between the equipment and receiver.
- Connect the equipment into an outlet on a circuit different from that to which the receiver is connected.
- Consult the dealer or an experienced radio/TV technician for help.

WARNING

The connection of a non-shielded equipment interface cable to this equipment will invalidate the FCC Certification of this device and may cause interference levels which exceed the limits established by the FCC for this equipment. It is the responsibility of the user to obtain and use a shielded equipment interface cable with this device. If this equipment has more than one interface connector, do not leave cables connected to unused interfaces. Changes or modifications not expressly approved by the manufacturer could void the user's authority to operate the equipment.

For Canadian Users

This Class B digital apparatus complies with Canadian ICES-003.

Cet appareil numérique de la classe B est conforme à la norme NMB-003 du Canada.

Copyright Notice

All rights reserved. No part of this publication may be reproduced, stored in a retrieval system, or transmitted in any form or by any means, electronic, mechanical, photocopying, recording, or otherwise, without the prior written permission of Seiko Epson Corporation. The information contained herein is designed only for use with this Epson product. Epson is not responsible for any use of this information as applied to other equipment.

Neither Seiko Epson Corporation nor its affiliates shall be liable to the purchaser of this product or third parties for damages, losses, costs, or expenses incurred by purchaser or third parties as a result of: accident, misuse, or abuse of this product or unauthorized modifications, repairs, or alterations to this product, or (excluding the U.S.) failure to strictly comply with Seiko Epson Corporation's operating and maintenance instructions.

Seiko Epson Corporation shall not be liable for any damages or problems arising from the use of any options or any consumable products other than those designated as Original Epson Products or Epson Approved Products by Seiko Epson Corporation.

Responsible Use of Copyrighted Materials

This unit is equipped with Macrovision copy protection. The intellectual property rights to the patent of this copy protection technology are owned by the Macrovision Company of America, and others. When employing this technology, a license is required from the Macrovision Company. The Macrovision Company does not authorize the use of this technology except for a limited range of intended purposes, including home use. Further, remodeling, disassembly, and reverse engineering are prohibited.

Reproduction of a disc for the purposes of broadcast, projection in public, public musical performance, or rental (regardless of compensation, remuneration, or lack thereof) without the permission of the copyright owner, is strictly prohibited.

Trademarks

Epson is a registered trademark and Epson Exceed Your Vision is a trademark of Seiko Epson Corporation.

Epson MovieMate is a trademark, PrivateLine is a registered trademark, and Extra Care and Epson Connection are service marks of Epson America, Inc.

Pixelworks, DNX, and the DNX logo are trademarks of Pixelworks, Inc.

General Notice: Other product names used herein are for identification purposes only and may be trademarks of their respective owners. Epson disclaims any and all rights in those marks.

© 2007 Epson America, Inc. 7/07

EPSON[®]
EXCEED YOUR VISION



411165900

CPD-24151
Printed in XXXXXX XX.XX-XX XXX